

**SANJIU COOLING EQUIPMENT
A TRUSTED BUSINESS PARTNER!**

**SANJIU
COOLING**

**Professional
Cooling Equipment & Solutions**



S
A
N
J
I
U

WUXI SANJIU COOLING EQUIPMENT CO., LTD.

101 XINJIN ROAD, JIANGSU PROVINCE, PRC.

TEL: +86-510-85312176 FAX: +86-510-85312676



CATALOGUE 3.1

Products can be modified without public notice.
All copy rights reserved. Edition 3.1





SOME CUSTOMERS

**EQUIPMENTS APPLIED
SANJIU PRODUCTS**

**MATERIALS
COOPERATORS**

- CIAE
 - CRRC CORPORATION
 - FAW-VOLKSWAGEN
 - NANJING AUTOMOBILE
 - DONGFENG-NISSAN
 - POSCO-CSPC
 - HAMON THERMAL
 - JOHNSON CONTROLS
 - IHI FENG DONG
 - NETUREN CO., LTD.
 - BODYCOTE THERMAL
 - EGYPTIAN METAL WORKS
- SRS INTERNATIONAL (CA)
 - OWENS ASSOCIATES (USA)
 - AIOLOS ENGINEERING (USA)
 - HICONICS DRIVE TECH.
 - ZHIGUANG ELECTRIC
 - TSINGHUA TONFANG
 - WANXIANG GROUP
 - TSINGTAO BREWERY
 - CHANGZHOU PHARMACEUTICAL
 - AAC TECHNOLOGIES
 - JEREH GROUP
 - SHENGSHAN GROUP
 - ...

ABOUT SANJIU

Share Advantages for Value Increase!

SANJIU Cooling is a professional manufacturer of cooling and heat exchange equipment, with advantages over cooling towers for water and other process fluids cooling of a wide range of applications.

The company is devoted to research, design, manufacturing, solutions, distribution and service of both standard and customized cooling equipment. The products have been exported widely to America, Canada, Australia, Chile, Russia, Mongolia, Venezuela, Croatia, Egypt, Jordan, Indonesia, Vietnam, India, etc., with representatives and agents overseas.

With joint efforts of Jiang Nan University, we have set up a R&D center for integrated water cooling solutions, and an advanced testing platform under directives of CTI. Our products are of high efficiency, superior corrosion resistance, low noise, environmental protection, easy installation, simple operation, and stable performance in long years' heavy duty service life.

The products are widely applied in various of fields, to cool circulating water, oil or other process fluid for HVAC System, Compressors, Data Centers, Ground Source Heat Pumps, Melting/ Vacuum/ Multi-crystal Furnaces, Induction Heaters, Printing Lines, Injection Machines, Casting Machines, Hydraulic Stations, Power Generators, Transformers, Converters, Refrigerators, Food and Chemical Production Lines, etc.

Our active staff is keen to share the knowledge and experiences with all customers and users, and we are always ready to provide the most competitive cooling equipment& solutions with continuous supports in the future!



GHM Series Evaporative Cooling Tower
Closed Circuit, Cross Flow



GTM Series Evaporative Cooling Tower
Closed Circuit, Counter Flow



GOM Series Steel Open Tower
Open Circuit, Cross Flow



GKM Series Dry Cooler



GZM Series Evaporative Condenser

► CATALOGUE

| | |
|------------------------------------|----|
| General Introduction | 01 |
| ----- | |
| -GHM Cross Flow Series | 05 |
| -GTM Counter Flow Series | 07 |
| -GOM Open Loop Series | 09 |
| -GKM Dry Cooling Series | 11 |
| -GZM Evaporative Condensing Series | 13 |
| ----- | |
| Product Features | 15 |
| Product Configurations | 17 |
| Customized Solutions | 23 |
| Typical Projects Reference | 25 |
| Technical Support | 35 |



Manufacturing First Grade Cooling Towers and Equipment with Advanced Technology & Facilities!

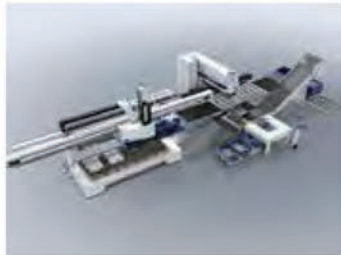

PRODUCTION

Standard production facilities with professional and experienced workers, strictly operated according to ISO9001, ISO14000, and 6S management.



QUALITY CONTROL

Thermodynamic test station designed and developed with joint efforts of Jiang Nan University, used to simulate the different working conditions, to carry out type tests according to CTI directives, ensure the heat exchange capacity and general performance of each tower made by Sanjiu Cooling.



Professional Testing System

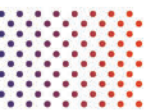

GHM SERIES

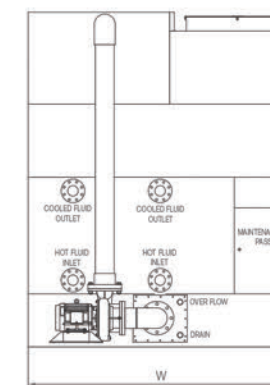
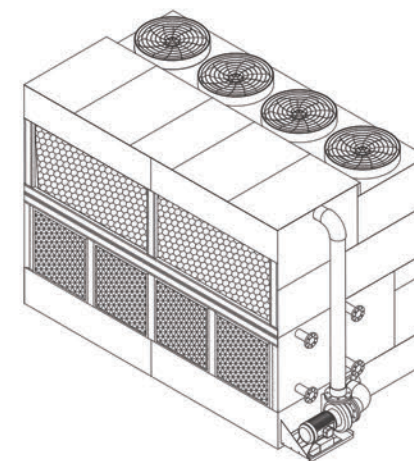

VIEW 1

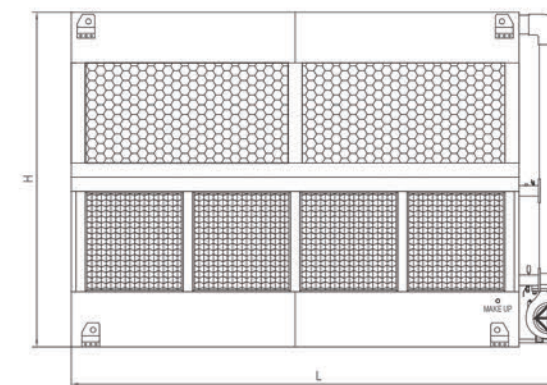

VIEW 2

CLOSED CROSS FLOW COOLING TOWER

GHM Series are of capacities from 30 to 366 nominal tons, can work in series as a group for larger capacities. Casing made in special alloy coated steel or stainless steel, Heat exchange coils made in stainless steel or red copper, Wet deck fills made in PVC. All raw materials are of high industrial grade, with superior corrosion resistant features. GHM towers are designed of high efficiency but lower initial and long term costs, easy and economical installation and maintenance. The towers dimensions can be customized to suit standard containers or particular project conditions. GHM towers are widely applied in different fields, to cool circulating water, oil or other process fluid for HVAC System, Compressors, Furnaces, Data Centers, Ground Source Heat Pumps, Power Generators, Transformers, Converters, Refrigerators, Food and Chemical Production Lines, etc.

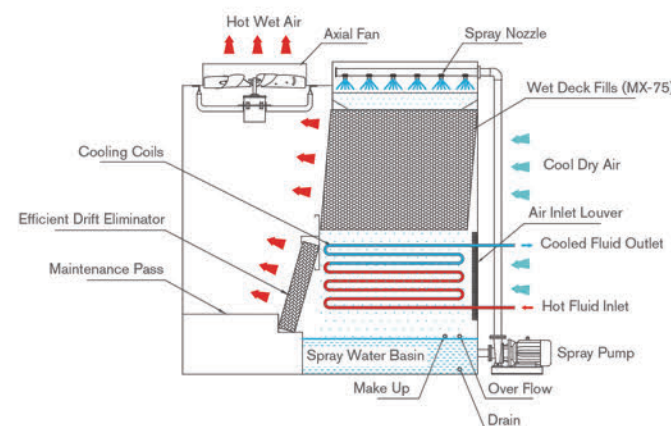

WORKING THEORY

GHM series belong to induced draft type cross flow cooling towers. During the working process, dry cool air is inlet through wide louvers on one side of the tower, then directed through the heat exchange coils and wet deck fills across the spray water, becoming wet hot air, eventually induced draught out of the tower into the atmosphere by the fans on the top. In this process, a part of heat from the fluids inside the closed loop is transferred efficiently, and removed continuously.

| Model No. | Nominal Tons | Fan | | Spray Pump | | Connecting Pipe (mm) | | | Overall Dimensions(mm) | | | Weight | |
|-----------|--------------|------------|-------------------|------------|-----------------|----------------------|---------|----------|------------------------|------|------|----------|----------------|
| | | Power (kW) | Air Volumn (m³/s) | Power (kW) | Flow Rate (T/h) | Inlet/Outlet | Make Up | Drainage | L | W | H | Net (kg) | Operation (kg) |
| GHM-225 | 30 | 1.1×2 | 3.7×2 | 1.5 | 45 | DN80 | DN25 | DN40 | 2540 | 1940 | 2200 | 1020 | 1820 |
| GHM-230 | 37 | 1.1×2 | 3.7×2 | 1.5 | 45 | DN80 | DN25 | DN40 | 2960 | 1940 | 2200 | 1050 | 2020 |
| GHM-235 | 43 | 1.1×2 | 3.7×2 | 1.5 | 45 | DN80 | DN25 | DN40 | 2960 | 1940 | 2200 | 1100 | 2100 |
| GHM-340 | 49 | 1.1×3 | 3.7×3 | 2.2 | 60 | DN80 | DN25 | DN40 | 3360 | 1940 | 2200 | 1310 | 2540 |
| GHM-350 | 61 | 1.1×3 | 3.7×3 | 2.2 | 60 | DN80×2 | DN25 | DN40 | 3760 | 2240 | 2200 | 1450 | 3080 |
| GHM-365 | 79 | 1.5×3 | 5.1×3 | 2.2 | 60 | DN80×2 | DN25 | DN40 | 3360 | 1940 | 2730 | 1520 | 3200 |
| GHM-380 | 98 | 1.5×4 | 5.1×4 | 2.2 | 114 | DN80×2 | DN25 | DN40 | 4220 | 2240 | 2680 | 2050 | 4920 |
| GHM-390 | 110 | 1.5×4 | 5.1×4 | 2.2 | 114 | DN80×2 | DN25 | DN40 | 4220 | 2240 | 2680 | 2100 | 5000 |
| GHM-3100 | 122 | 1.5×4 | 5.1×4 | 2.2 | 114 | DN80×2 | DN25 | DN40 | 4220 | 2240 | 2840 | 2150 | 5100 |
| GHM-3110 | 134 | 1.5×4 | 5.1×4 | 2.2 | 114 | DN80×2 | DN25 | DN40 | 4220 | 2240 | 2840 | 2250 | 5250 |
| GHM-5125 | 152 | 1.5×4 | 5.1×4 | 3.7 | 140 | DN100×2 | DN40 | DN40 | 4740 | 2240 | 2910 | 2800 | 6800 |
| GHM-5150 | 183 | 2.2×4 | 6.3×4 | 3.7 | 140 | DN100×2 | DN40 | DN40 | 5440 | 2240 | 2910 | 3200 | 7820 |
| GHM-5175 | 213 | 2.2×4 | 6.3×4 | 3.7 | 140 | DN125×2 | DN40 | DN40 | 5440 | 2240 | 2910 | 3300 | 8000 |
| GHM-7200 | 244 | 4×4 | 16.7×4 | 5.5 | 160 | DN125×2 | DN40 | DN40 | 5840 | 2900 | 3260 | 5000 | 9000 |
| GHM-7225 | 274 | 4×4 | 16.7×4 | 5.5 | 160 | DN125×2 | DN40 | DN40 | 5840 | 2900 | 3470 | 5500 | 10000 |
| GHM-7250 | 305 | 4×4 | 16.7×4 | 5.5 | 160 | DN150×2 | DN40 | DN40 | 6420 | 2900 | 3470 | 6500 | 11500 |
| GHM-7275 | 335 | 4×4 | 16.7×4 | 5.5 | 160 | DN150×2 | DN40 | DN40 | 6420 | 2900 | 3470 | 6800 | 11800 |
| GHM-7300 | 366 | 4×4 | 16.7×4 | 5.5 | 160 | DN150×2 | DN40 | DN40 | 6420 | 2900 | 3470 | 7000 | 12000 |

NOTE

Nominal Tons are based upon temp. drop 35~29.5°C/ 95~85°F, WBT 25.5°C/ 78°F, and 0.681 m³/hr/ton.

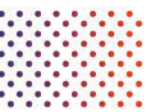

GTM SERIES

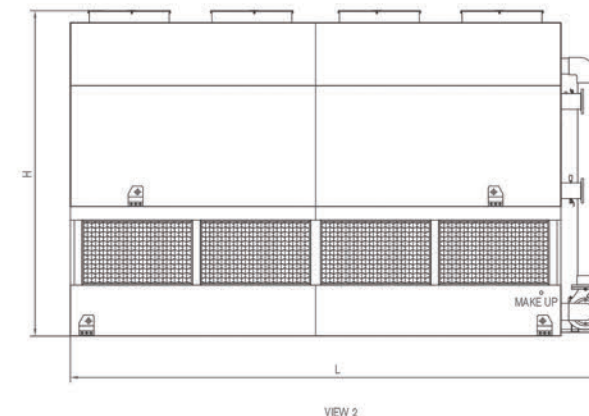
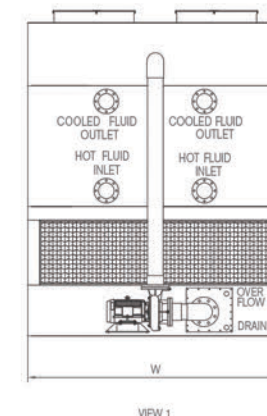
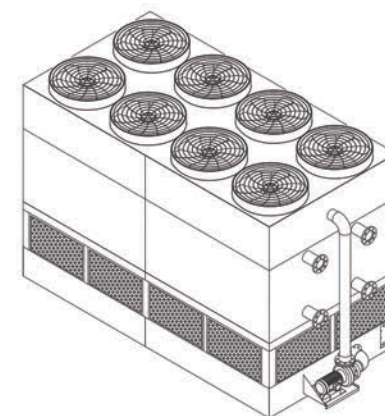

CLOSED COUNTER FLOW COOLING TOWER

GTM Series are of regular capacities from 6 to 305 nominal tons. Casing made in special alloy coated steel or stainless steel, Heat exchange coils made in stainless steel or red copper. GTM Towers tend to be more compact, taking less installation space, working without any wet deck fill, more suitable to cool hot water of higher inlet temperature. The towers dimensions can be customized to suit standard containers or particular project conditions. GTM towers are widely applied in different fields, to cool circulating water, oil or other process fluid for Melting/ Vacuum/ Multi-crystal Furnaces, Induction Heaters, Compressors, Heat Pumps, Metal Parts Production Lines, Hydraulic Stations, Power Generators, Transformers, Converters, etc.

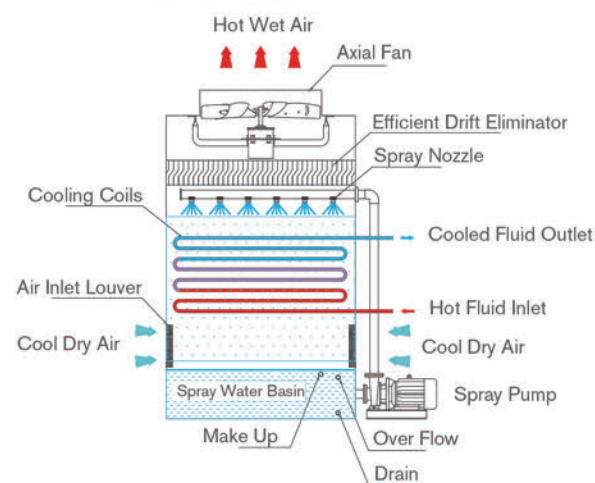

WORKING THEORY

As counter flow towers, the dry cool air is inlet through louvers on both sides of the tower from the bottom, and drawn upwards passing a large heat exchange surface of the coils section under the induced fans, against the spraying water in the opposite way, becoming hot wet air, induced draught out of the tower into the atmosphere by the fans on the top. During this process, a part of the heat from the fluids inside the closed loop is transferred efficiently, and removed to the outside environment.

| Model No. | Nominal Tons | Fan | | Spray Pump | | Connecting Pipe(mm) | | | Overall Dimensions(mm) | | | Weight | |
|-----------|--------------|------------|-------------------|------------|-----------------|---------------------|---------|----------|------------------------|------|------|----------|----------------|
| | | Power (kW) | Air Volumn (m³/s) | Power (kW) | Flow Rate (T/h) | Inlet/Outlet | Make Up | Drainage | L | W | H | Net (kg) | Operation (kg) |
| GTM-15 | 6 | 0.55 | 2.4 | 0.75 | 20 | DN50 | DN25 | DN40 | 2200 | 1000 | 1830 | 450 | 700 |
| GTM-110 | 12 | 0.55 | 2.4 | 0.75 | 20 | DN50 | DN25 | DN40 | 2400 | 1000 | 1900 | 490 | 800 |
| GTM-115 | 18 | 0.55×2 | 2.4×2 | 0.75 | 20 | DN65 | DN25 | DN40 | 2300 | 1020 | 1830 | 460 | 1000 |
| GTM-120 | 24 | 0.55×2 | 2.4×2 | 0.75 | 20 | DN65 | DN25 | DN40 | 2300 | 1020 | 1900 | 500 | 1050 |
| GTM-225 | 30 | 0.55×2 | 2.4×2 | 1.5 | 45 | DN80 | DN25 | DN40 | 2860 | 1240 | 2050 | 730 | 1650 |
| GTM-230 | 37 | 1.1×2 | 3.7×2 | 1.5 | 45 | DN80 | DN25 | DN40 | 2860 | 1240 | 2180 | 830 | 1760 |
| GTM-235 | 43 | 1.1×2 | 3.7×2 | 1.5 | 45 | DN65×2 | DN25 | DN40 | 2860 | 1240 | 2420 | 1050 | 2030 |
| GTM-340 | 49 | 1.5×2 | 5.1×2 | 2.2 | 60 | DN65×2 | DN25 | DN40 | 2860 | 1520 | 2440 | 1280 | 2500 |
| GTM-350 | 61 | 1.5×2 | 5.1×2 | 2.2 | 60 | DN80×2 | DN25 | DN40 | 2860 | 1520 | 2630 | 1370 | 2660 |
| GTM-365 | 79 | 1.1×4 | 3.7×4 | 2.2 | 60 | DN80×2 | DN25 | DN40 | 3200 | 1760 | 2630 | 1820 | 3460 |
| GTM-370 | 85 | 1.1×4 | 3.7×4 | 2.2 | 114 | DN80×2 | DN25 | DN40 | 3200 | 2120 | 2750 | 1930 | 3970 |
| GTM-380 | 98 | 1.5×4 | 5.1×4 | 2.2 | 114 | DN80×2 | DN25 | DN40 | 3200 | 2120 | 2750 | 2050 | 4000 |
| GTM-390 | 110 | 1.5×4 | 5.1×4 | 2.2 | 114 | DN80×2 | DN25 | DN40 | 3200 | 2120 | 2750 | 2150 | 4050 |
| GTM-3100 | 122 | 1.5×4 | 5.1×4 | 2.2 | 114 | DN80×2 | DN25 | DN40 | 3550 | 2120 | 2750 | 2330 | 4710 |
| GTM-3110 | 134 | 1.5×6 | 5.1×6 | 2.2 | 114 | DN80×2 | DN25 | DN40 | 4150 | 2120 | 2870 | 2650 | 5550 |
| GTM-5125 | 152 | 1.5×8 | 5.1×8 | 3.7 | 140 | DN100×2 | DN40 | DN40 | 4750 | 2120 | 2970 | 3100 | 6500 |
| GTM-5150 | 183 | 1.5×8 | 5.1×8 | 3.7 | 140 | DN100×2 | DN40 | DN40 | 5050 | 2120 | 3120 | 3500 | 7480 |
| GTM-7175 | 213 | 1.5×8 | 5.1×8 | 5.5 | 160 | DN125×2 | DN40 | DN40 | 5480 | 2120 | 3120 | 3800 | 8240 |
| GTM-7200 | 244 | 1.5×8 | 5.1×8 | 5.5 | 160 | DN125×2 | DN40 | DN40 | 5080 | 2620 | 3120 | 4800 | 9170 |
| GTM-7225 | 274 | 1.5×8 | 5.1×8 | 5.5 | 160 | DN125×2 | DN40 | DN40 | 5480 | 2620 | 3220 | 5600 | 11300 |
| GTM-10250 | 305 | 1.5×10 | 5.1×10 | 7.5 | 240 | DN150×2 | DN40 | DN40 | 6230 | 2620 | 3220 | 6000 | 12560 |

NOTE

Nominal Tons are based upon temp. drop 35~29.5°C/ 95~85°F, WBT 25.5°C/ 78°F, and 0.681 m³/hr/ton.

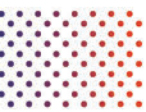

HIGH EFFICIENCY · LOW NOISE
ANTI-CORROSIVE · LONG SERVICE LIFE
STABLE PERFORMANCE

GOM
SERIES



GOM SERIES

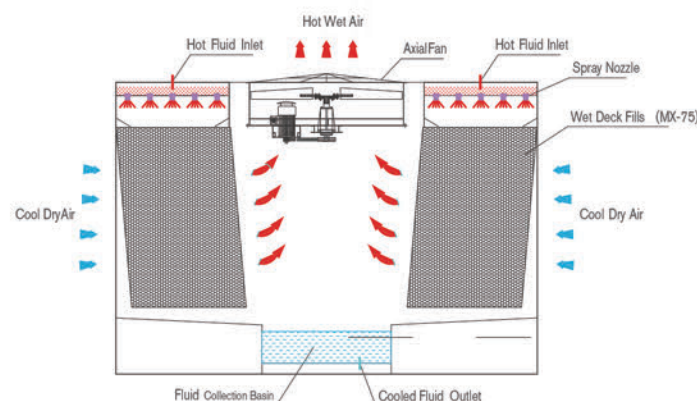
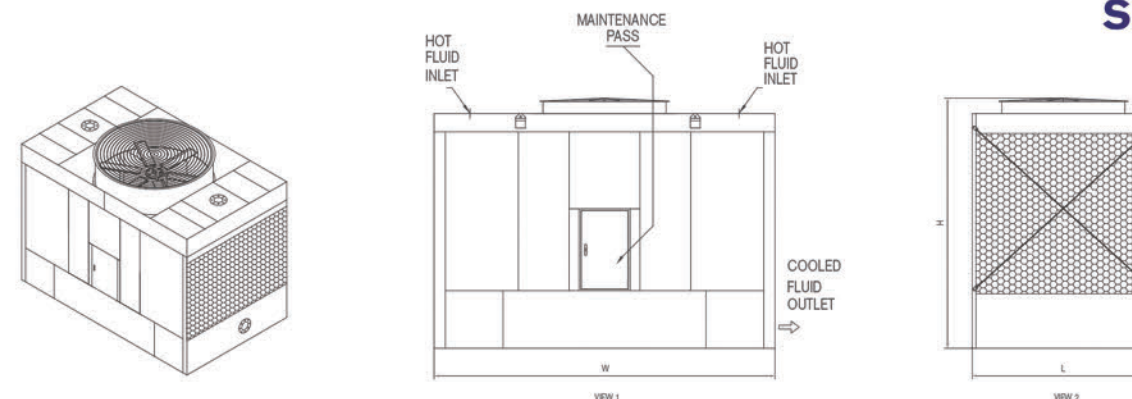

OPEN COOLING TOWER

GOM Series cross flow steel open cooling towers are generally of higher capacities, can work in series as a group for large projects. Enclosure made in special alloy coated steel or stainless steel. GOM towers are of optimized firm structure, high efficiency, low drift rate, and anti blocking. The towers dimensions can be customized to suit standard containers or particular project conditions. GOM towers are widely applied in different fields, to cool circulating water for Melting Furnaces, Induction Heaters, Metal Parts Production Lines, Hydraulic Stations, Power Generators, and other utilities requiring massive cooling water, but not highly demanding on water quality. Initial invest in open towers is lower, but water consumption rate is higher comparing to closed loop cooling towers.

WORKING THEORY

In GOM open cooling towers, the hot water is inlet to the water distribution basin on the top of the tower firstly, and spread onto the extensive surface of the wet deck fills after flowing through the spreading holes by gravity. Meanwhile the dry cool air is inlet through the side louvers of the tower, passing the fills across the water falls. During this process, a part of water is evaporated, with heat removed. The wet hot air is induced draught out of the tower into the atmosphere by the fans on the top, while the cooled water is collected back to the bottom collection basin with the eliminator, flowing back to the equipment requiring cooling water.

| Model No. | Nominal Tons | Fan power (kW) | Connecting Pipe (mm) | | | | | Overall Dimensions(mm) | | | Weight | | |
|-----------|--------------|----------------|----------------------|---------|---------|----------|-------|------------------------|------|------|----------|----------------|-------|
| | | | Inlet | Outlet | Make Up | Overflow | Drain | L | W | H | Net (kg) | Operation (kg) | |
| GOM0109 | S-1 | 136 | 3.7 | DN150×2 | DN150 | DN25 | DN50 | DN50 | 1980 | 3910 | 3200 | 1800 | 3500 |
| | Q-1 | 156 | 5.5 | DN150×2 | DN150 | DN25 | DN50 | DN50 | 1980 | 3910 | 3200 | 1800 | 3500 |
| | P-1 | 171 | 7.5 | DN150×2 | DN150 | DN25 | DN50 | DN50 | 1980 | 3910 | 3200 | 1800 | 3500 |
| GOM0115 | Q-1 | 208 | 5.5 | DN150×2 | DN150 | DN25 | DN50 | DN50 | 2550 | 4300 | 3220 | 2150 | 4600 |
| | P-1 | 231 | 7.5 | DN150×2 | DN150 | DN25 | DN50 | DN50 | 2550 | 4300 | 3220 | 2150 | 4600 |
| GOM0215 | Q-1 | 264 | 5.5 | DN200×2 | DN200 | DN25 | DN50 | DN50 | 2550 | 5530 | 3730 | 3350 | 7100 |
| | P-1 | 291 | 7.5 | DN200×2 | DN200 | DN25 | DN50 | DN50 | 2550 | 5530 | 3730 | 3350 | 7100 |
| | O-1 | 322 | 11 | DN200×2 | DN200 | DN25 | DN50 | DN50 | 2550 | 5530 | 3730 | 3350 | 7100 |
| | N-1 | 363 | 15 | DN200×2 | DN200 | DN25 | DN50 | DN50 | 2550 | 5530 | 3730 | 3350 | 7100 |
| GOM0120 | M-1 | 383 | 18.5 | DN200×2 | DN200 | DN25 | DN50 | DN50 | 2550 | 5530 | 3730 | 3350 | 7100 |
| | Q-1 | 312 | 5.5 | DN200×2 | DN200 | DN40 | DN65 | DN50 | 3010 | 6070 | 3750 | 3850 | 8500 |
| | P-1 | 347 | 7.5 | DN200×2 | DN200 | DN40 | DN65 | DN50 | 3010 | 6070 | 3750 | 3850 | 8500 |
| | O-1 | 395 | 11 | DN200×2 | DN200 | DN40 | DN65 | DN50 | 3010 | 6070 | 3750 | 3850 | 8500 |
| | N-1 | 433 | 15 | DN200×2 | DN200 | DN40 | DN65 | DN50 | 3010 | 6070 | 3750 | 3850 | 8500 |
| | M-1 | 460 | 18.5 | DN200×2 | DN250 | DN40 | DN65 | DN50 | 3010 | 6070 | 3750 | 3850 | 8500 |
| GOM0126 | L-1 | 481 | 22 | DN200×2 | DN250 | DN40 | DN65 | DN50 | 3010 | 6070 | 3750 | 3850 | 8500 |
| | P-1 | 393 | 7.5 | DN200×2 | DN200 | DN40 | DN65 | DN50 | 3620 | 6400 | 3750 | 4850 | 11200 |
| | O-1 | 449 | 11 | DN200×2 | DN250 | DN40 | DN65 | DN50 | 3620 | 6400 | 3750 | 4850 | 11200 |
| | N-1 | 490 | 15 | DN200×2 | DN250 | DN40 | DN65 | DN50 | 3620 | 6400 | 3750 | 4850 | 11200 |
| GOM0132 | M-1 | 529 | 18.5 | DN200×2 | DN250 | DN40 | DN65 | DN50 | 3620 | 6400 | 3750 | 4850 | 11200 |
| | L-1 | 560 | 22 | DN200×2 | DN250 | DN40 | DN65 | DN50 | 3620 | 6400 | 3750 | 4850 | 11200 |
| | K-1 | 610 | 30 | DN200×2 | DN250 | DN40 | DN65 | DN50 | 3620 | 6400 | 3750 | 4850 | 11200 |
| | O-1 | 513 | 11 | DN250×2 | DN250 | DN40 | DN65 | DN50 | 4230 | 6830 | 3750 | 5750 | 13600 |
| GOM0226 | N-1 | 563 | 15 | DN250×2 | DN250 | DN40 | DN65 | DN50 | 4230 | 6830 | 3750 | 5750 | 13600 |
| | M-1 | 605 | 18.5 | DN250×2 | DN250 | DN40 | DN65 | DN50 | 4230 | 6830 | 3750 | 5750 | 13600 |
| | L-1 | 637 | 22 | DN250×2 | DN250 | DN40 | DN65 | DN50 | 4230 | 6830 | 3750 | 5750 | 13600 |
| | K-1 | 700 | 30 | DN250×2 | DN300 | DN40 | DN65 | DN50 | 4230 | 6830 | 3750 | 5750 | 13600 |
| GOM0326 | J-1 | 753 | 37 | DN250×2 | DN300 | DN40 | DN65 | DN50 | 4230 | 6830 | 3750 | 5750 | 13600 |
| | O-1 | 555 | 11 | DN250×2 | DN250 | DN50 | DN65 | DN65 | 3620 | 6830 | 4970 | 7250 | 15200 |
| | N-1 | 608 | 15 | DN250×2 | DN250 | DN50 | DN65 | DN65 | 3620 | 6830 | 4970 | 7250 | 15200 |
| | M-1 | 654 | 18.5 | DN250×2 | DN250 | DN50 | DN65 | DN65 | 3620 | 6830 | 4970 | 7250 | 15200 |
| GOM0332 | L-1 | 694 | 22 | DN250×2 | DN250 | DN50 | DN65 | DN65 | 3620 | 6830 | 4970 | 7250 | 15200 |
| | K-1 | 757 | 30 | DN250×2 | DN300 | DN50 | DN65 | DN65 | 3620 | 6830 | 4970 | 7250 | 15200 |
| | J-1 | 811 | 37 | DN250×2 | DN300 | DN50 | DN65 | DN65 | 3620 | 6830 | 4970 | 7250 | 15200 |
| | N-1 | 658 | 15 | DN250×2 | DN250 | DN50 | DN65 | DN65 | 3620 | 6830 | 5840 | 7950 | 16900 |
| GOM0332 | M-1 | 703 | 18.5 | DN250×2 | DN300 | DN50 | DN65 | DN65 | 3620 | 6830 | 5840 | 7950 | 16900 |
| | L-1 | 741 | 22 | DN250×2 | DN300 | DN50 | DN65 | DN65 | 3620 | 6830 | 5840 | 7950 | 16900 |
| | K-1 | 805 | 30 | DN250×2 | DN300 | DN50 | DN65 | DN65 | 3620 | 6830 | 5840 | 7950 | 16900 |
| | J-1 | 857 | 37 | DN250×2 | DN300 | DN50 | DN65 | DN65 | 3620 | 6830 | 5840 | 7950 | 16900 |
| GOM0332 | N-1 | 742 | 15 | DN250×2 | DN300 | DN50 | DN65 | DN65 | 4230 | 6830 | 5840 | 8650 | 19400 |
| | M-1 | 791 | 18.5 | DN250×2 | DN300 | DN50 | DN65 | DN65 | 4230 | 6830 | 5840 | 8650 | 19400 |
| | L-1 | 835 | 22 | DN250×2 | DN300 | DN50 | DN65 | DN65 | 4230 | 6830 | 5840 | 8650 | 19400 |
| | K-1 | 907 | 30 | DN250×2 | DN300 | DN50 | DN65 | DN65 | 4230 | 6830 | 5840 | 8650 | 19400 |
| GOM0332 | J-1 | 968 | 37 | DN250×2 | DN300 | DN50 | DN65 | DN65 | 4230 | 6830 | 5840 | 8650 | 19400 |
| | I-1 | 1017 | 45 | DN250×2 | DN350 | DN50 | DN65 | DN65 | 4230 | 6830 | 5840 | 8650 | 19400 |

NOTE

Nominal Tons are based upon temp. drop 35~29.5°C/ 95~85°F, WBT 25.5°C/ 78°F, and 0.681 m³/hr/ton.

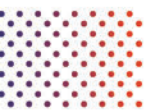

HIGH EFFICIENCY · LOW NOISE
ANTI-CORROSIVE · LONG SERVICE LIFE
STABLE PERFORMANCE

GKM
SERIES



GKM SERIES

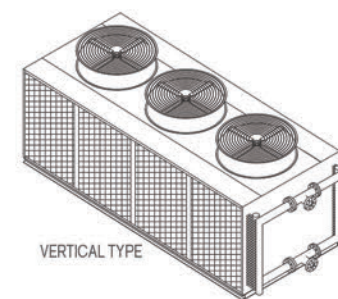

VERTICAL TYPE

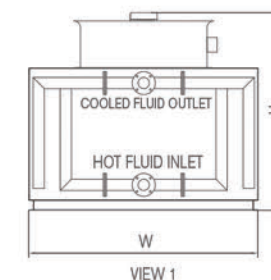

VIEW 1

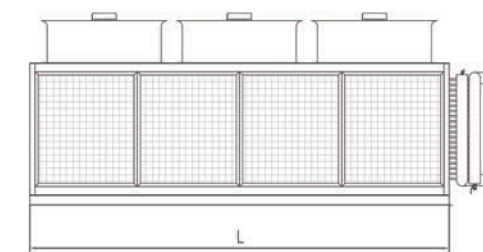

VIEW 2

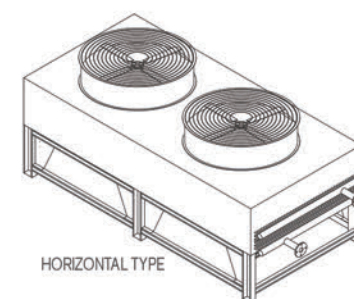

HORIZONTAL TYPE

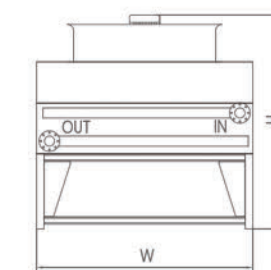

VIEW 1

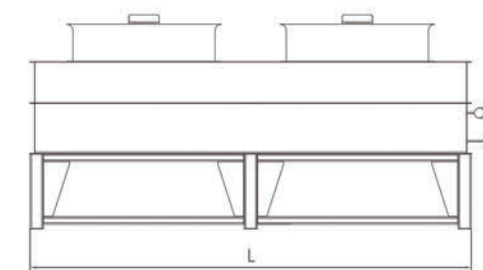

VIEW 2

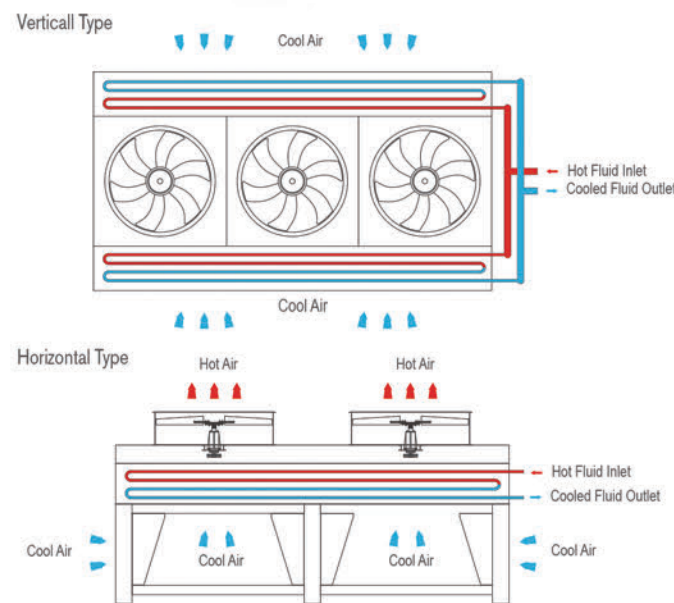

DYR AIR COOLING TOWER

GKM Dry Cooling Series have been developed since 2012, with a wide range of cooling capacities. Enclosure made special alloy coated steel, or stainless steel optional. Heat exchange coils made in copper tube or stainless steel tubes fitted with aluminum or copper fins around the tubes. The fluid inlet and outlet are set on the same side, easy in installations. The overall dimensions can be tailor-made to suit standard containers or particular project conditions. GKM Towers are more widely applied to cool process fluids (water, oil, or gas) of generally higher temperature, such as for Air Compressors, Furnaces, Heaters, and other utilities in Gas Stations, Refinery Industries, etc., especially in the area short of water resources.

WORKING THEORY

Dry cooling towers work without spray water. High volume of air is inlet continuously through the louvers, going through the large surface of heat exchange coils with intensive fins. Heat from the process fluid inside the coils is transferred to the high speed flowing air efficiently, and induced draught out of the tower into the atmosphere by the strong fans on the top.

| Model No. | Nominal Tons | Fan | | Water Inlet / Outlet | Overall Dimensions(mm) | | | Weight (kg) |
|-----------|--------------|------------|-------------------------------|----------------------|------------------------|------|------|-------------|
| | | Power (kW) | Air Volum (m ³ /s) | | L | W | H | |
| GKM-90H | 16 | 6 | 15 | DN65 | 3200 | 1240 | 2350 | 950 |
| GKM-110H | 20 | 9 | 18.3 | DN65 | 3900 | 1240 | 2350 | 1050 |
| GKM-135H | 25 | 9 | 22.5 | DN65 | 4200 | 1392 | 2350 | 1250 |
| GKM-160H | 30 | 12 | 26.7 | DN65 | 4500 | 1544 | 2350 | 1500 |
| GKM-185H | 35 | 12 | 30.6 | DN65 | 4700 | 1696 | 2350 | 1700 |
| GKM-200V | 40 | 16.5 | 33.3 | DN80 | 4500 | 2200 | 2150 | 2200 |
| GKM-220V | 45 | 16.5 | 36.1 | DN80 | 4500 | 2200 | 2260 | 2500 |
| GKM-250V | 50 | 16.5 | 41.7 | DN80 | 4500 | 2200 | 2420 | 3000 |
| GKM-280V | 55 | 16.5 | 47.2 | DN100 | 5000 | 2200 | 2500 | 3800 |
| GKM-315V | 60 | 22.5 | 52.8 | DN100 | 5000 | 2200 | 2650 | 4300 |
| GKM-355V | 65 | 22.5 | 61.1 | DN100 | 5400 | 2200 | 2650 | 4950 |
| GKM-400V | 75 | 22.5 | 66.7 | DN100 | 5400 | 2200 | 2780 | 5250 |
| GKM-450V | 85 | 30 | 75 | DN100 | 5500 | 2200 | 2920 | 5800 |
| GKM-500V | 94 | 30 | 83.3 | DN100 | 5600 | 2200 | 2800 | 6500 |

NOTE

Nominal Tons are based upon temp. drop 47~41°C/ 117~106°F, DBT 35°C/ 95°F.

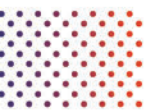

GZM SERIES

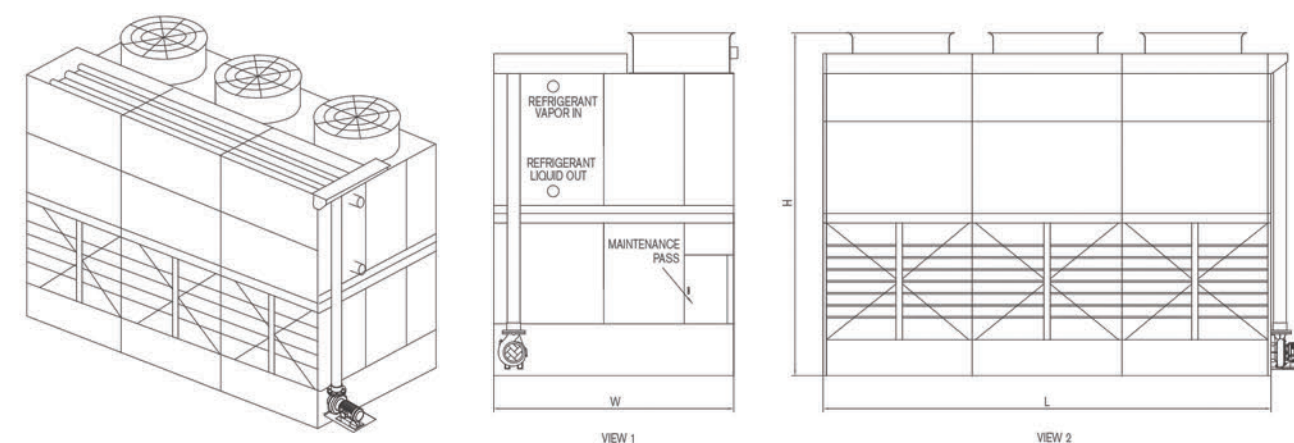

EVAPORATIVE CONDENSER

GZM Series Evaporative Condensers are made in the same types of materials as GHM and GTM Series, and of similar working theory as a type of Evaporative Coolers, but designed dedicatedly to cool process fluids of refrigerant, of which the forms are changed during the process.

The equipment utilize the evaporation of partial spray water, to absorb the heat from the flowing gaseous refrigerant of high temperature inside the condensing coils, and cool the refrigerant from gaseous state to liquid form.

In a complete evaporative cooling system, compressor discharges high pressure evaporated refrigerant in gas form, which passes through the heat exchange coils of evaporative condenser, and exchanges heat with spray water outside the heat exchange coils. After entering heat exchange coils from upper inlet, gaseous refrigerant is gradually cooled to be liquid form from top down. The strong wind of fans makes spray water fully cover the

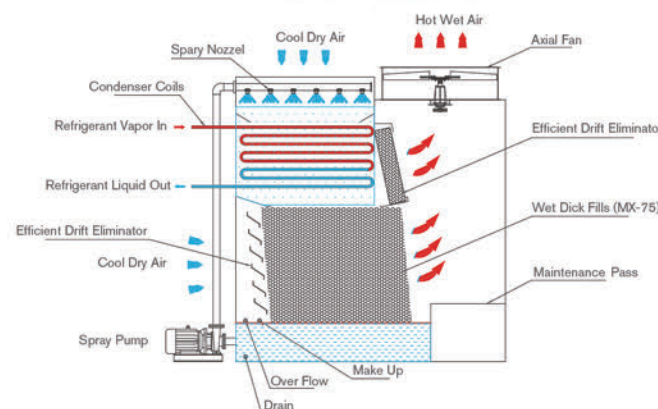

heat exchange surface of the coils evenly, and this tremendously increases the heat exchange efficiency. Partial caefactive spray water gets vaporized and takes away massive heat with the air flow. Small water drops in hot air are intercepted by high efficient drift eliminator, collected and fall back to wet deck fills together with hot spray water, then gets cooled by flowing air, eventually return to the spray water basin after temperature decreased. This whole process is recycling by the circulating pump, and the evaporated spray water is made up automatically by water level regulator.

| Model No. | Nominal Tons | Fan | | Spray Pump | | Gas Inlet | Liquid Outlet | Overall Dimensions(mm) | | | Weight | |
|-----------|--------------|------------|--------------------------------|------------|-----------------|-----------|---------------|------------------------|------|------|----------|----------------|
| | | Power (kW) | Air Volumn (m ³ /s) | Power (kW) | Flow Rate (T/h) | | | L | W | H | Net (kg) | Operation (kg) |
| GZM-100 | 100 | 1.1 | 3.9 | 0.75 | 16 | DN40 | DN32 | 1130 | 770 | 2800 | 500 | 970 |
| GZM-115 | 115 | 1.5 | 5 | 0.75 | 16 | DN40 | DN32 | 1150 | 890 | 3025 | 600 | 1070 |
| GZM-130 | 130 | 1.5 | 5 | 0.75 | 16 | DN40 | DN32 | 1150 | 890 | 3025 | 620 | 1100 |
| GZM-145 | 145 | 1.5 | 5.6 | 0.75 | 16 | DN40 | DN32 | 1160 | 1050 | 3075 | 800 | 1280 |
| GZM-160 | 160 | 1.5 | 5.6 | 0.75 | 16 | DN40 | DN32 | 1160 | 1050 | 3075 | 820 | 1300 |
| GZM-180 | 180 | 2.2 | 6.9 | 0.75 | 16 | DN80 | DN80 | 1710 | 1125 | 3210 | 1150 | 1630 |
| GZM-200 | 200 | 2.2 | 6.9 | 0.75 | 16 | DN80 | DN80 | 1710 | 1125 | 3210 | 1170 | 1650 |
| GZM-220 | 220 | 3 | 7.5 | 0.75 | 16 | DN80 | DN80 | 1835 | 1220 | 3210 | 1250 | 1950 |
| GZM-240 | 240 | 3 | 7.5 | 0.75 | 16 | DN80 | DN80 | 1835 | 1220 | 3210 | 1270 | 1970 |
| GZM-280 | 280 | 3 | 8.9 | 0.75 | 16 | DN80 | DN80 | 1680 | 1220 | 3400 | 1200 | 1900 |
| GZM-300 | 300 | 3 | 8.9 | 0.75 | 16 | DN80 | DN80 | 1680 | 1220 | 3400 | 1220 | 1920 |
| GZM-320 | 320 | 4 | 11.1 | 0.75 | 16 | DN80 | DN80 | 1880 | 1250 | 3400 | 1400 | 2100 |
| GZM-340 | 340 | 4 | 11.1 | 0.75 | 16 | DN80 | DN80 | 1880 | 1250 | 3400 | 1420 | 2120 |
| GZM-360 | 360 | 4 | 12.5 | 0.75 | 22 | DN80 | DN80 | 2000 | 1350 | 3400 | 1650 | 2350 |
| GZM-380 | 380 | 4 | 12.5 | 0.75 | 22 | DN80 | DN80 | 2000 | 1350 | 3400 | 1670 | 2370 |
| GZM-400 | 400 | 4 | 12.5 | 0.75 | 22 | DN80 | DN80 | 2000 | 1350 | 3400 | 1690 | 2390 |
| GZM-430 | 430 | 4 | 18.1 | 1.5 | 45 | DN100 | DN100 | 1830 | 2410 | 4300 | 2490 | 3830 |
| GZM-475 | 475 | 4 | 18.1 | 1.5 | 45 | DN100 | DN100 | 1830 | 2410 | 4300 | 2700 | 4050 |
| GZM-495 | 495 | 5.5 | 19.7 | 1.5 | 45 | DN100 | DN100 | 1830 | 2410 | 4300 | 2710 | 4060 |
| GZM-550 | 550 | 4 | 17.6 | 2.2 | 75 | DN100 | DN100 | 1930 | 3010 | 4350 | 3310 | 4980 |
| GZM-595 | 595 | 5.5 | 21.7 | 2.2 | 75 | DN100 | DN100 | 1930 | 3010 | 4350 | 3320 | 4990 |
| GZM-670 | 670 | 5.5 | 21.7 | 2.2 | 75 | DN100 | DN100 | 1930 | 3010 | 4350 | 3700 | 5380 |
| GZM-700 | 700 | 5.5 | 21.7 | 2.2 | 75 | DN100 | DN100 | 1930 | 3010 | 4950 | 3800 | 5890 |
| GZM-735 | 735 | 7.5 | 24.2 | 2.2 | 75 | DN100 | DN100 | 1930 | 3010 | 4950 | 3810 | 5900 |
| GZM-780 | 780 | 5.5 | 22.2 | 2.2 | 75 | DN100 | DN100 | 1985 | 3210 | 4990 | 4040 | 6200 |
| GZM-870 | 870 | 7.5 | 27.8 | 2.2 | 75 | DN100 | DN100 | 1985 | 3210 | 4990 | 4050 | 6210 |
| GZM-940 | 940 | 11 | 34.7 | 2.2 | 75 | DN100 | DN100 | 1985 | 3210 | 4990 | 4060 | 6220 |
| GZM-960 | 960 | 4.0×2 | 18.1×2 | 2.2 | 114 | DN100×2 | DN100 | 3575 | 2410 | 4300 | 4920 | 7590 |
| GZM-1000 | 1000 | 5.5×2 | 19.7×2 | 2.2 | 114 | DN100×2 | DN100 | 3575 | 2410 | 4300 | 4940 | 7610 |
| GZM-1050 | 1050 | 7.5×2 | 21.9×2 | 2.2 | 114 | DN100×2 | DN100 | 3575 | 2410 | 4300 | 4960 | 7630 |
| GZM-1165 | 1165 | 4.0×2 | 17.6×2 | 3.7 | 140 | DN100×2 | DN100 | 3775 | 2710 | 4950 | 6070 | 10210 |
| GZM-1285 | 1285 | 5.5×2 | 21.7×2 | 3.7 | 140 | DN100×2 | DN100 | 3775 | 2710 | 4950 | 6090 | 10230 |
| GZM-1335 | 1335 | 7.5×2 | 24.2×2 | 3.7 | 140 | DN100×2 | DN100 | 3775 | 2710 | 4950 | 6110 | 10250 |
| GZM-1420 | 1420 | 5.5×2 | 21.7×2 | 3.7 | 140 | DN100×2 | DN100 | 3775 | 3010 | 4950 | 7050 | 11250 |
| GZM-1490 | 1490 | 7.5×2 | 24.2×2 | 3.7 | 140 | DN100×2 | DN100 | 3775 | 3010 | 4950 | 7070 | 11270 |

NOTE

Nominal Tons are based upon condensing temp. 37°C/ 98.6°F, WBT 26°C/ 78.8°F.

PRODUCTS ADVANTAGES

**Compatible with numerous process fluids
(water, water/glycol, oil, other fluids)**

- ◆ Capable and flexible in customized solutions
- ◆ Factory assembled for maximal installation convenience
- ◆ Modular design suits a wide range of heat rejection duties
- ◆ Compact design with minimal footprints
- ◆ Multiple corrosion resistant options
- ◆ Low sound operation options available
- ◆ More optimizing options available
- ◆ Performance and quality guaranteed
- ◆ Super long service life



TOP DESIGN & QUALITY FEATURES

1 Entirely Corrosion Proof

- ◆ Enclosure made in Special Alloy Coated Steel from Nippon Steel/POSCO, or Stainless Steel;
- ◆ Heat Exchange Coils or Condenser Coils made in Stainless Steel, Red Copper, or Titanium Alloy
- ◆ Tube for Chemical Fluid Cooling;
- ◆ Structure Frame and Lifting Lug in H.D.G Steel, Fasteners in Stainless Steel, or Dacromet Treated .



2 Heat Exchange Performance Ensured

- ◆ Models Passed Strict Type Test



3 Solid Structure

- ◆ Strong Reinforcing Bars
- ◆ Intensive Fasteners
- ◆ Low Gravity Center with Heat Exchanger in Bottom Section

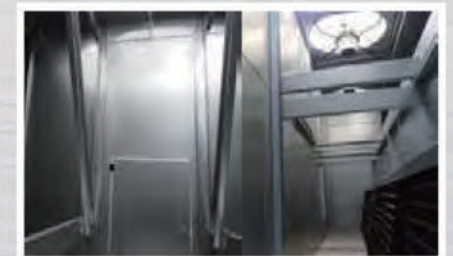

4 Maintenance & Cleaning Convenient

- ◆ Large Entering Access
- ◆ Cooling Coils Section Visible
- ◆ Water Basin with Efficient Drain



5 High Unit Power Efficiency

- ◆ Advanced System Design
- ◆ Optimized Fans and Pumps



SANJIU Standard cooling towers apply the latest type of Highly Corrosion-resistant coated steel sheet with a coating composition consisting of zinc as the main substrate, in combination with Al(11%), Mg(3%), and a trace amount of silicon. This special material is named as 'SuperDyma' by Nippon Steel.

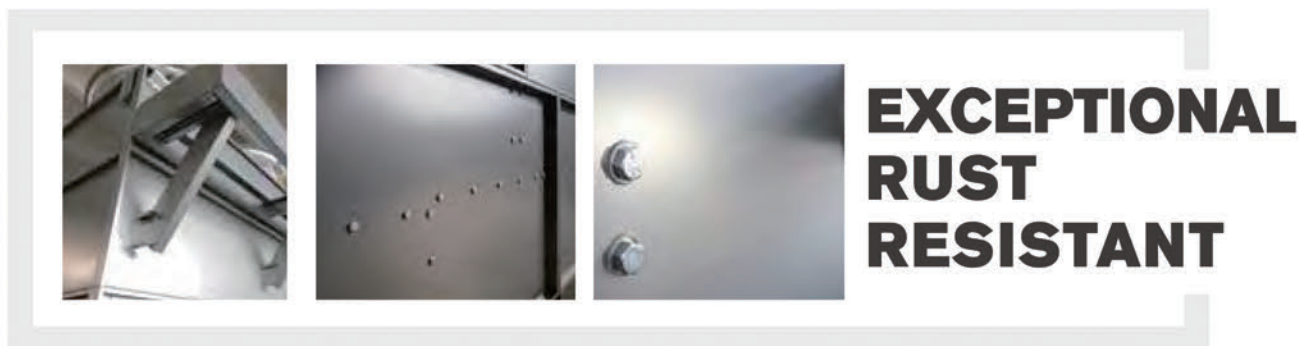

- ◆ Not only highly rust resistant on flat surfaces;
- ◆ But also superiorly corrosion proof on cut-end surfaces, self 'recovered'.
- ◆ In addition, of extremely high alkaline resistance.

The corrosion resistance of this innovative alloy coated steel is enhanced by the composite effect of adding aluminum, magnesium and silicon to the conventional zinc coating. Silicon, among other elements, is highly effective in inhibiting corrosion when combined with Magnesium.

Corrosion Resistance at Cut-end Surfaces (Results of Salt Spray Tests)

| Specimen conditions Thickness: 3.2 mm Surface treatment: No treatment | Hot-dip Zn-coated sheet Coating mass: 100 g/m ² /side | SuperDyma Coating mass: 90 g/m ² /side | Galvalume Steel Sheet (Laboratory trial-made sample) Coating mass: 90 g/m ² /side |
|---|---|--|--|
| Salt spray test: 500 hours | | | |

Corrosion Resistance of Flat Surfaces

Conventional hot-dip Zn-coated steel sheets also produce a protective film. However, this film is rough in texture, allowing the penetration of moisture and oxygen and a resultant growth of corrosion.

By contrast, the dense protective film formed on the surface of SuperDyma arrests the corrosion process and stabilizes corrosion behavior

Corrosion Resistance of Flat Surfaces (Salt Spray Tests)

| Test time | Before test | 500 hours | 1,000 hours | 2,000 hours |
|--|-------------|-----------|-------------|-------------|
| SuperDyma Thickness: 3.2 mm Coating mass symbol: K12 Special chromate treatment | | | | |

Corrosion Resistance at Cut-end Surfaces

Results of Outdoor Exposure Tests

- ◆ In the actual exposure environment outdoors, a slight degree of initial red rust occurs on cut-end surfaces, but, after a while, a stable protective film covers the cut-end surface, thus virtually arresting further progress of corrosion in the long run.
- ◆ Red rust which occurs in the initial phase is arrested in progress, with time, by the effect of the protective film and, soon entirely covered by the film, becomes quite inconspicuous.

Corrosion Resistance at Cut-end Surfaces: Initial Period

| Specimen conditions SuperDyma Thickness: 3.2mm Coating mass symbol: K27 Surface treatment: Special chromate treatment (Y treatment) Exposure site: Urayasu Plant of KANEYASU Co. | Downward |
|---|----------|
| Original | |
| 7 days | |
| 14 days | |
| 1 month | |
| 2 month | |
| 3 month | |

Corrosion Resistance at Cut-end Surfaces: Middle and Latter Periods (Results of Outdoor Exposure Tests)

Specimen conditions SuperDyma
Thickness: 3.2 mm
Coating mass: 90g/m² /side (K18)
Surface treatment: No treatment

Exposure site: Nippon Steel & Sumitomo Metal's weathering site at Futtsu

Set direction of cut-end surfaces

| | Upward | Sideways (The left is the underside in the photo) | Downward |
|-----------|--------|--|----------|
| 8 months | | | |
| 20 months | | | |

| Specime | Type of coating | Coating mass | Surface treatment | Thickness |
|-------------------------|--------------------------|--------------|----------------------------|-----------|
| Hot-dip Zn-coated sheet | Zn | Z27 | Special chromate treatment | 1.6mm |
| SuperDyma | -3%Mg-0.2%Si Zn-11%Al | K18 | | |
| Galvalume Steel Sheet | Zn-55%Al | AZ150 | | |

Test conditions:
Cyclic corrosion test (JASO M609-91 method)
Repetition of ① to ③ as a cycle
① Salt spray: 2 hours (5% NaCl, 35°C)
② Drying: 4 hours (60°C)
③ Wetting: 2 hours (50°C, humidity 95% or more)

Corrosion Resistance of Flat Surfaces (Results of JASO)

| | 90 cycles | 180 cycles |
|-------------------------|-----------|------------|
| Hot-dip Zn-coated sheet | | |
| SuperDyma | | |
| Galvalume Steel Sheet | | |

Superior Raw Materials, Advanced Tech Design, Precise Fabricating Equipments, All These Created Reliable Cooling Towers of SANJIU!

BASIC CONFIGURATIONS

STRUCTURE & CASING



The standard enclosure is made of the latest type of Highly Corrosion-resistant coated steel sheet with a coating composition consisting of Zn+Al(11%)+Mg(3%), and a trace amount of silicon, originally imported from Nippon Steel or Posco. The panels are sheared and folded precisely in whole cold machining process, then densely bolted and sealed for water tightness, with sufficient reinforcing bars, preventing deforming during hoisting process in fields. Each tower is completed with maintenance access and doors of maximized size, for internal inspection convenience. Heat exchange section is firmly supported by frame made in stainless steel, or H.D.G steel plated entirely after welding.

EVAPORATIVE COOLING COILS



The water cooling series adopt high efficient heat exchange coils. Optimized coils has effectively reduced air-side resistance, suitable to work with larger amount of spray water, and significantly improved heat transfer efficiency. The heat exchanger combines one or more coils supported by steel structure, firm and durable. This whole section is of patented design, easy to eliminate cooling medium fluid. Standard coils tube made in stainless steel 304/316, or red copper and titanium ally on option. Different wall thickness can be met on request. Each coil is tested under continuous nitrogen gas pressure of 30 bar for 24 hours, ensure no leaking or weak point, with guarantee provided for 18 for both raw material and design of this critical section of an evaporative cooler.

DRY/AIR COOLING COILS



The dedicated dry cooling coils in GKM Series is used exclusively for the purpose of dry cooling, fitted with particularly shaped aluminum or steel fins around the coils tubes, to maximize heat transfer surface and efficiency. The gap between the neighbouring fins can be customized and depends on the environment and other working conditions of the project sites. Dry cooling coils with suitable fin gaps can also work with spray water in cases the temperature drop becomes a challenge in the hot season, and save operation power greatly. Rest of specifications is common to above evaporative cooling coils.



DIRECT-DRIVE AXIAL FANS

The standard closed loop series adopt direct-drive axial fans, fitted with resin or al-alloy airfoil blades perfectly balanced and coupled to a weather proof TEFC three-phases electric motor. The fan casing is a galvanized steel cylinder to draw the air vertically and avoid the risk of recirculation. The tip speed of the impeller is limited to keep the noise level within acceptable limits.



NON-DIRECT DRIVE AXIAL FANS

A part of open loop series adopt non-direct drive axial fans, fitted with al-alloy airfoil blades perfectly balanced and coupled with gear box or belts with speed reducer, to a weather proof TEFC three-phases electric motor. The fan casing is a galvanized steel cylinder to draw the air vertically and avoid the risk of recirculation. The tip speed of the impeller is limited to keep the noise level within acceptable limits.



SPRAY PUMP

Standard spray pumps are of GZ horizontal centrifugal series from GSD brand, with motor of brand TECO, specially designed for evaporative cooling equipments, of generally large flow rate but low pumping head. The selected pumps are of dynamic-static balance, with shaft as an extended section from the motor, for most reliable concentricity. With first grade bearings, the pumps runat minimized vibration and low noise. Mechanicseals avoids abrasion to shaft, no leakage in long term service life. Overload protected on any point of the performance curve, not exceeding the rated power during the whole working period. Enclosure materials and installation arrangement can be optional and modified to suit different projects requirements.



WET DECK FILL

The fills are formed in flame-retardant PVC sheets with a special shape design of herringbone surface, to distribute water evenly over the entire fill area for maximal thermal performance, can be integrated with air inlet louvers and drift eliminators. For medium fouled water, fill types with enlarged grids are available to reduce the chances of blocks. All the raw materials are of virgin grade from approved suppliers, with long service life in tough environment.



DRIFT ELIMINATOR

Cellular Drift Eliminators are specifically designed to achieve maximum drift removal, with significantly lower pressure drop. The modules are constructed of a series of sinusoidal-shaped, corrugated PVC sheets that are mechanically assembled to mating sinusoidal structural waves, forming closed cells. These cells force the drift droplets being carried in the leaving airstream to make three distinct changes in direction. When the air is forced to change direction, the inertia of the water droplets keeps them moving in a straight line, causing them to impact the wall of the drift eliminator and drain back into the wet section of the tower.

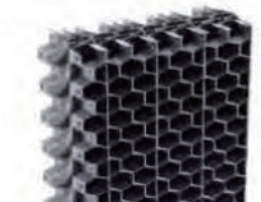

AIR INLET LOUVERS

Cellular air Inlet louvers with advaned design improve air flow into the cooling tower, keep out debris, eliminate water splash-out, which otherwise can cause icing, near-site water damage, and unnecessary water loss. The deign restrict the amount of sunlight into the cooling tower to impede algae growth, reduce noise from the tower, and improve the tower's appearance.

BASIC CONFIGURATIONS



SPRAY NOZZLES FOR OPEN TOWERS

The Spiral Target Nozzles used for GOM Series open towers, injection molded in polypropylene unit consisting of two parts, main body with integral target diffuser and a snap-on insert or orifice cap. The nozzles installed in bottom of the hot water distribution basins, to eliminate water diffusion decks below the hot water basins, provide full water coverage of the fills by gravity flow, removable and replaceable but of long service life. Sizes and variety depends on the tower size, water flow rate and water quality.



SPRAY PIPE

Spray Pipes made in U-PVC from FPC, of high mechanical strength and long service life, holding pressure 1.0 Mpa, accessible to inspect and maintain from outside of the tower, convenient to check with when running fully, completed with buttonholes for quick and tight installations of spray nozzles.



FLOAT VALVE

Heavy duty floating valve, made in stainless steel, floating ball in engineering plastic or stainless steel, with long service life. Water level adjustable.



ANTI-EDDY FILTER

Effectively filtering the sundries, with anti-eddy arrangement, preventing air bubbles sucked into the pumps, punched in the same material as the enclosure, highly corrosion resistant.



FASTNERS

Fastners of leading brands, standard materials in steel dacromet treated, stainless steel on options. Intensity of fastners is higher than average.

OPTIONAL CONFIGURATIONS



CONTROL PANEL

The control panel is optional for each cooling tower, or a group of towers can share a central control station. The enclosure can be made in powder coated carbon steel, or stainless steel on options, with or without weather proof arrangement.



PLC DIGITAL CONTROL

In cases digital or remote control function required, the PLC can be applied and programmed according to the project demands, with or without PC connection terminal, usually of brand Simens or AB.



CIRCULATION AUXILIARY SECTION

Circulation Pumps with Transfer Water Tank, as an integrated solution of circulating system, with PID design on request.



FREQUENCY CONTROL

An optional part to adjust the frequency of power supply.



PROTECTIVE GUARDS AND MAINTENANCE LADDER

For maintenance convenience and safety, made in HDG steel or stainless steel.



LOW NOISE FANS

Fans with low noise design, suitable for installation locations with strict noise limit, 6 to 12 db(a) lower than standard fan system.



VIBRATION REDUCER

An optional part applied to reduce running vibration when necessary, of nature frequency 2.16Hz ~ 4.79Hz



VIBRATION LIMIT SWITCH

Used to switch off the tower automatically when the vibration is out of limit when the tower is working abnormally.



ELETRICAL HEATER

Applied to heat the freezing water when restarting the tower during winter season in some area



AUTO MAKE UP UNIT

An optional part to make up the liquid automatically, to be working together with liquid level controller.

CUSTOMIZED SOLUTIONS

Casing in Stainless Steel



Surface Finish with Paint



Heat Exchange Section in Titanium for Superior Corrosion Resistant



Water/ Air Cooling Hybrid



Auto Anti- Freeze Structure



Fog Dissipation Treatment



Integrated Solution with Frame and Circulation System



Explosion Proof Treatment



Fabricating at Project Site



TYPICAL PROJECTS

Air Compressor Cooling First Auto Works



◆ Stage IV



◆ Stage I



◆ Stage II



◆ Stage III

HVAC Cooling Changzhou Pharmaceutical Factory, Johnson Controls Plant



◆ For YORK A/C



◆ For Trane A/C



TYPICAL PROJECTS

Vacuum Furnace Cooling



◆ For Jinfei Holding Group



◆ For IHI Feng Dong

Melting Furnace Cooling



◆ For SiDa MF. Induction Furnace

TYPICAL PROJECTS

Oil and Other Process Fluid Cooling



◆ DONGFENG-NISSAN /Massive Quenching Oil



◆ Hangzhou Sannai Enviroment/ Transformer Oil



◆ Pusheng Chemical/ Formaldehyde

Groud Source Heat Pump System Cooling



◆ Xuyi Hospital



◆ Tsinghua Tonfang

TYPICAL PROJECTS

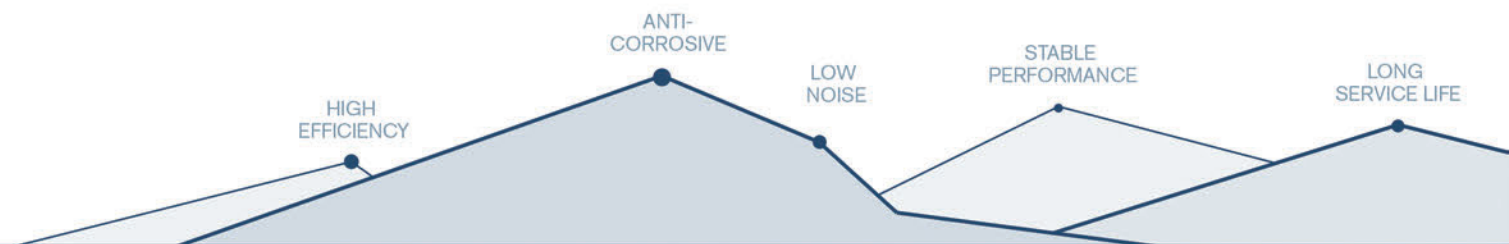

◆ For Tsingtao Brewaery

OTHER UTILITIES COOLING

Data Centers,
 Frequency Converters,
 Injection Machines, Printing Lines,
 Drawbenches, Polycrystalline Furnaces, etc.



◆ For Tsingtao Brewaery



◆ For Xinjiang Baomo Petrochemical



◆ For Zhiguang Electric

TYPICAL PROJECTS



◆ For Xinjiang Baomo Petrochemical

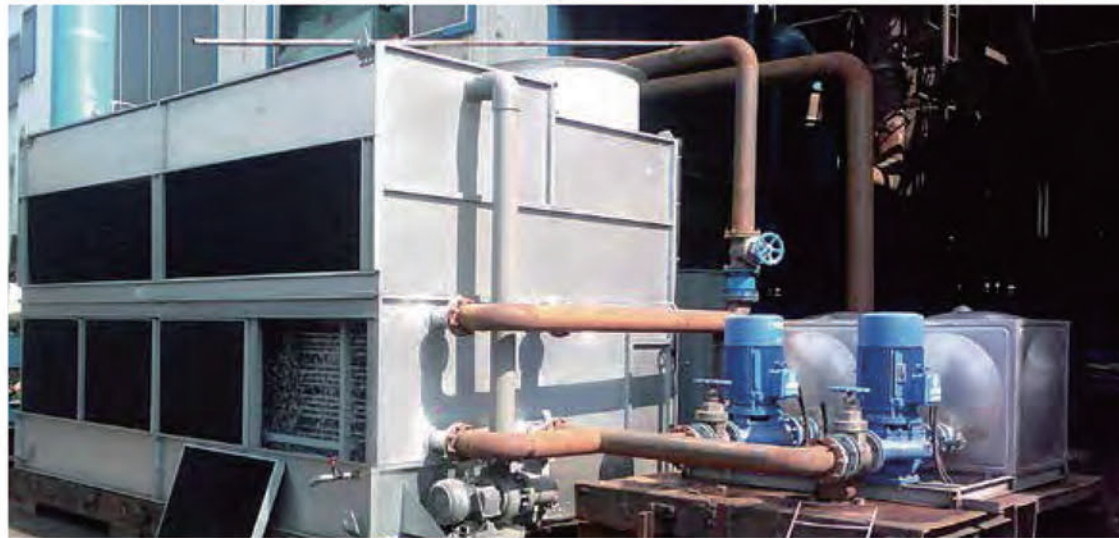

◆ For New United Group

TRANSPORTATION CONVENIENCE



The products are of considerate modular design and tailor-made to suit containers loading, or flat racks for extremely large models, firmly fixed for transportation safety.



TECH SUPPORT & INSTALLATION GUIDES

RECOMMENDED SPRAY WATER CONDITION

| Items | Standard Value | |
|--|--|--|
| | When the temp. of circulating water < 20°C | When the temp. of circulating water if between 20°C~60°C |
| Ph value | 6.8~8.0 | 7.8~8.0 |
| Conductivity (ms/cm) | < 40 | < 30 |
| Chloride rate (mg Cl ⁻ /L) | < 50 | < 50 |
| Sulphate rate (mg SO ₄ ²⁻ /L) | < 50 | < 50 |
| Acid consumption rate(Ph4.8)(mg CaCO ₃ /L) | < 50 | < 50 |
| Total hardness(mg CaCO ₃ /L) | < 70 | < 70 |
| Calcium hardness(mg CaCO ₃ /L) | < 50 | < 50 |
| CO ₂ ionized rate (mg SiO ₂ /L) | < 30 | < 30 |
| Iron ion rate (mg Fe/L) | < 1.0 | < 1.0 |
| Copper ion rate (mg Cu/L) | < 1.0 | < 1.0 |
| Residual Chloride rate(mg Cl/L) | < 0.3 | < 0.3 |
| Ammonium ion rate (mg NH ₄ ⁺ /L) | < 1.0 | < 1.0 |
| Residual Carbonic acid rate(mg CO ₂ /L) | < 4.0 | < 0.4 |

SPECIAL NOTES FOR WINTERTIME OR COLD ENVIRONMENT OPERATION

To prevent the cracking of condenser coils and the reticulation system in general, please take the precautions below when operating in cold environments.

When the ambient temperature is lower than -10°C, it is necessary to add an antifreeze agent to prevent the recirculating water from freezing. Typical dosing rates for glycol based antifreeze please refer to below chart, or please consult us for further advice.

| Glycol (%) | 0 | 10 | 20 | 30 | 40 | 50 | 58 |
|---------------------|------|------|----|-----|-----|-----|-----|
| Freezing point (°C) | -0.0 | -3.5 | -8 | -15 | -24 | -36 | -48 |

NOTE

If the tower is idle when the ambient temperature is below 0°C, it will be essential to completely drain all water from the tower and associated piping.

1.LOCATION

The cooling tower should be installed on a solid floor, to avoid resonance, vibration and noise. The tower should be located in an open area, with sufficient space - about 2 meters away from any wall to allow for effective air flow. The location should be free of airborne pollutants – and away from acidic and explosive environments in particular.

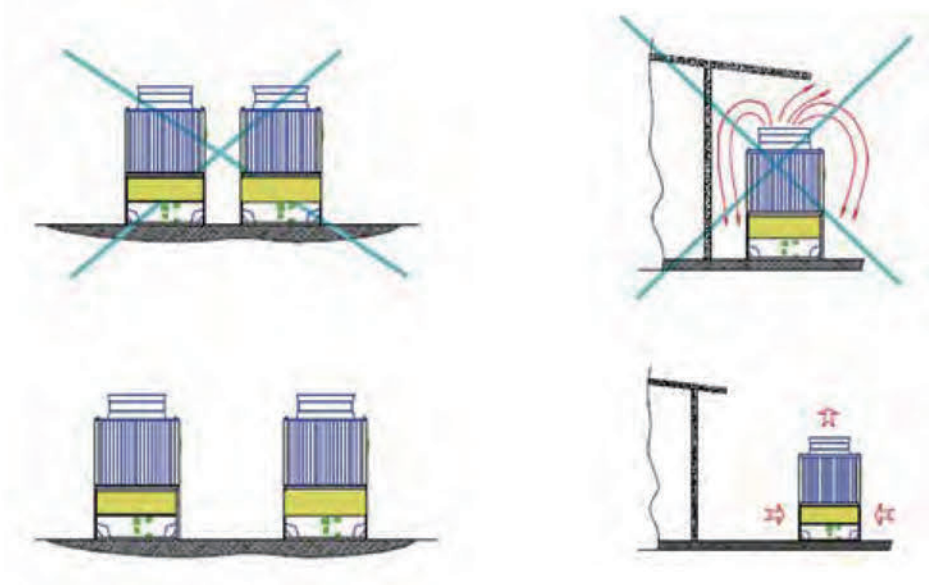

2.PRECAUTIONS

- Check the nameplate and confirm the power supply is suitable for the tower
- Prevent backflow of water vapor or hot wet air
- Provide drainage around the tower (fall > 0.8%) around the base of the tower to remove any condensate water or minor overspray
- Comply with all local Electrical and Building Regulations during the installation

3.PLUMBING

- Select a suitable type and size of water pipe to connect the water inlet and outlet
- Fix the external water pipes properly. Pipes must not be supported by the tower

4.ELECTRICAL CONNECTION

- Standard power supply is 380V±10%, 3-Phase, 50 Hz. If this has been customized to your requirements, the details will be indicated on the tower nameplate as well as at the front of the instruction manual.
- For further details, please refer to the Electrical Diagram Drawings provided along with the tower.

NOTE

Foundation design is provided for each project. Commissioning & Operation guides please refer to the service manual of each product. For further technical support, please contact us.